

(See 256AL
Pump Manual
Parts List)

#	Part# ¹	Description	QTY
1	141MF-150NY	QC Adapter 90° Male QC x FNPT 1-1/2" Polypropylene	1
2	149FE-150NY	QC Adapter 90° Female QC x FNPT 1-1/2" Polypropylene	1
3	155QC-150NY	QC Cap 1-1/2" Propylene	1
4	157MM-150NY	QC Adapter Male QC x MNPT 1-1/2"	1
5	159MA-150NY	Hose Coupling, Threaded Male 1-1/2"	4
6	160-A-1023	Elbow, 1-1/2" 90° Schedule 80 PVC Female NPT	1
7	160-A-1533	Ball Valve, 1/2" Compact PVC	1
8	160-A-1534	Nipple, 1/2" Close, PVC Schedule 80	1
9	160-A-1551	Tank, 25 Gallon Poly Tank for Caddy 28202	1
10	160-A-1552	Bushing, Reducer, Machined, 2" Male to 1-1/2" Female	1
11	160-A-2365	Hose, 1-1/2" Water Suction/Discharge	2'
12	160-A-1592	Lanyard, 304 Stainless Wire Rope 8"	1
13	160-A-2371	Tire, 10.6" 2 Ply x 2.25 Offset, Axel .75 4.10/3.50-4	2
14	160-B-605	Pump Caddy Frame, Painted	1
15	F3/16-2.5-CP	3/16 x 2-1/2 SS Cotter Pin	2
16	256AL-150	Compact Manual Vertical Mount Pump, Aluminum	1
17	152FM-150NY	QC Adapter - 1.5" Female QC x 1.5" Male NPT	1
18.1	160-A-2365	Hose, 1.5" ID Water Suction/Discharge	20
18.2	156MA-150NY	QC Hose Coupling - 1.5" Male QC x 1.5" Hose Barb	1
18.3	156FE-150NY	QC Hose Coupling - 1.5" Female QC x 1.5" Hose Barb	1
18.4	160-A-2887	Hose Clamp	8
18.5	160-A-2365-TUBE	Yellow Sleeve (10")	2
19	27220	Pumpout Nozzle with Splash Guard - Male QC 1.5"	1
20	160-A-1941	Pipe PVC, 1-1/2" Schedule 40	3

IMPORTANT

For air tight suction lines,
all threads must be sealed.
Use appropriate pipe
sealant or Teflon tape in
assembly.

How To Use and Operate The Edson Pumpout Caddy-Model 28202

Before You Begin

1. Wear gloves
2. Make sure your holding tank valves are positioned for deck fill pumpout
3. The holding tank **MUST** be vented

1. Open Boat Waste cap

1-1/2" Quick Clamp Deck Adapter

For waste deck fills with 1-1/2" thread on the fill cap

1-1/4" Quick Clamp Deck Adapter

For waste deck fills with 1-1/4" thread on the fill cap

If you do not use the supplied nozzle, optional threaded adapters can be purchased

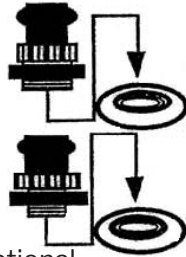

1a. Clamp Pumpout nozzle into end of hose

Quick clamp pumpout nozzle clamps into end of suction hose and can be used with any deck fill.

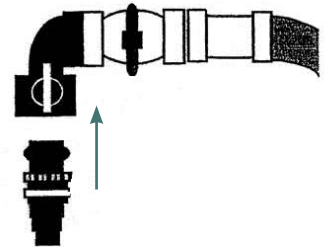

Must be held in place while pumping

2. Unwind hose all the way

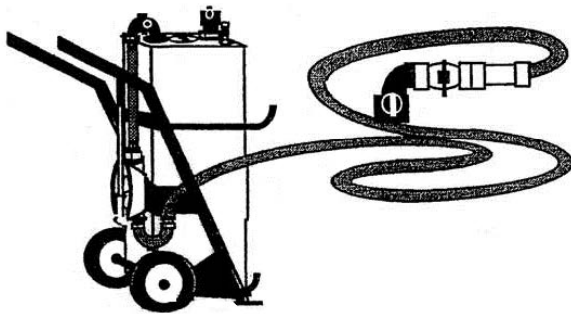

3. Insert suction on deck fill

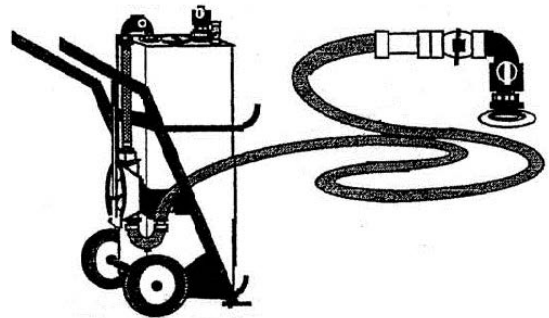

4. Open valve on tank & hose

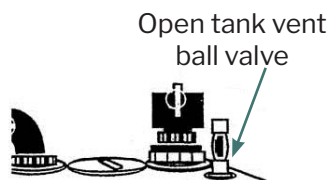

5. Pump by moving handle in & out

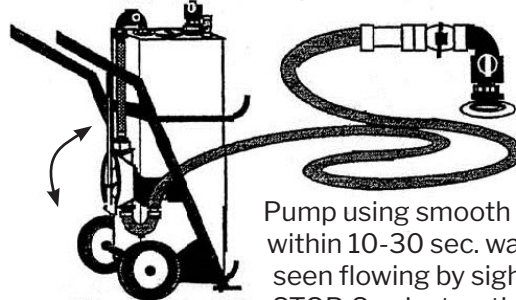

Pump using smooth steady action; within 10-30 sec. waste should be seen flowing by sight glass. If not **STOP**. See instructions on page 3

6. Stop pumping - Flush boat toilet - repeat 4 & 5

1. Flush entire waste system from the toilet
2. Flush by pumping clean water through the toilet, not through the deck fill
3. Flush until the sight glass runs clear
4. Flushing is the best way to prevent odor

7. Stow hose & rinse area with fresh water

Rinse deck & equipment

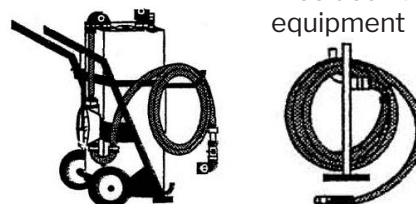

Emptying Edson Pumpout Caddy - 28202

1. Hook discharge hose to sewer system
Use optional extra hose if necessary

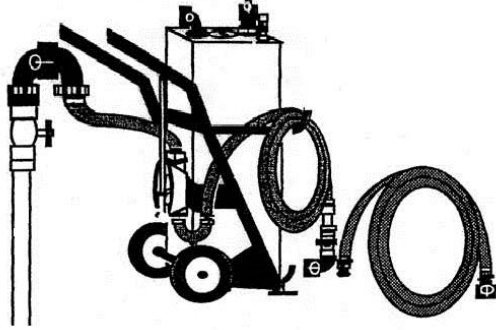

2. Clamp suction hose to collection tank pumpout adapter - open tank valves

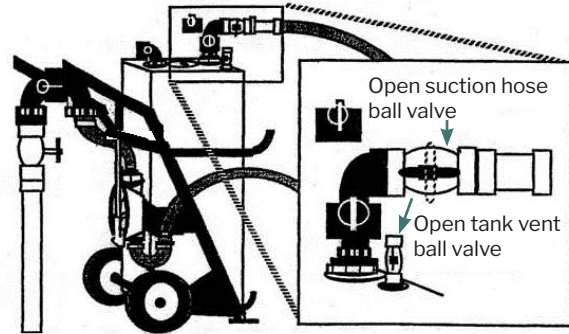

3. Flush system with available water by:

1. Removing tank access cap
2. Rinse tank using fresh water
3. Pump until sight glass runs clear & tank is clean and empty
4. Flushing is the best way to prevent odor

4. Reconnect discharge hose to tank and close valves. Wash equipment & hands

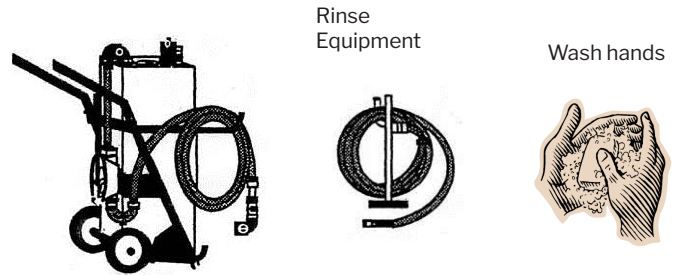

If pumpout does not work after 30 seconds of pumping - STOP - pumping harder will not make it work

1. Check boat holding tank for correct valve position and venting
2. Check for tight connection of suction hose to deck adapter
3. Check hose and that tank ball valves are opened
4. Try pumping again
5. If waste still does not pump: call attendant - see operations manual - call Edson (508) 995-9711



Operations & Parts Manual
Model 256AL-150 Vertical Mount Pump

CAUTION

Special applications - Edson pumps are used for many diverse applications. Some may require special parts or maintenance procedure. I.e. pumping liquid with gasoline or other fuels requires using Viton diaphragms and valves. If you have any questions regarding procedures for your application, call Edson customer service.

Set Up
Installing the Pump

1. Install the pump in a manner that allows for a comfortable position for pumping and easy access for inspection and maintenance.
2. The head ring and drive arm can be rotated to the four 90° positions allowed by the square bolt pattern. (Fig 5 Page 2)
3. The pump is designed to be installed on a relatively horizontal surface using 1/4" bolts or screws at the four corners of the base (Fig 5). If the mounting surface can not be horizontal, the inlet port should be lower than the discharge.
4. Do not combine incompatible metals i.e. no aluminum fittings on a bronze pump or bronze fittings on an aluminum pump.
5. Check that all nuts and bolts are tight (Fig 5). Requires two 7/16 and one phillips screw driver.

Installing the Plumbing

1. Fittings and hose couplings must be air tight. Threads must be sealed with pipe sealer.
2. To avoid clogging, the discharge should be the same size or larger than the inlet.
3. Connect plumbing to the pump using unions or easily removed couplings.
4. Sewage and sump applications using backup check valves on the inlet and discharge will improve the ability of the pump to dry prime.
5. For sewage and sump applications where the discharge drains naturally down and away from the pump, installing a positive loop will improve the self priming feature. When you stop pumping the loop traps some liquid against the discharge valve improving the seal. Fig 1
6. When discharging to a point higher than the pump. Install the discharge plumbing so that no air can be trapped in the plumbing. Fig 2&3. Trapped air restricts the flow of liquid and requires more work to pump liquid past the air lock.
7. If the pump is being installed to pump liquids with suspended solids and the use will be intermittent, solid matter can get trapped under the check valves. This will prevent self priming at the next use. Flushing with water will generally clear out the solid matter. Installing secondary clear flapper check valves right at the inlet and discharge will improve the dry suction start performance of the pump. Order Edson clear check valve 269CL-150.

Operation

The Pump Works By:

1. Pulling back on the handle raises the diaphragm creating a vacuum.
2. The vacuum pulls the discharge valve assembly closed.
3. Atmospheric pressure pushes liquid up the inlet plumbing to fill the vacuum.
4. Pushing forward on the handle compresses the air and liquid under the diaphragm closing the inlet check valve and forcing the air and liquid out the discharge.
5. The closing of the inlet valve assembly prevents the liquid and air trapped in the inlet from dropping back to atmosphere.

Installing the Plumbing

1. An air tight diaphragm
2. Valve assemblies that seal well on the pump inlet and discharge valve seats.
3. Inlet plumbing that is air tight all the way to the point it is submersed in the liquid.

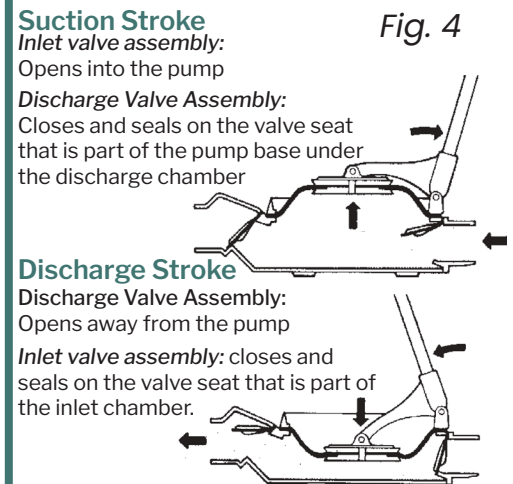
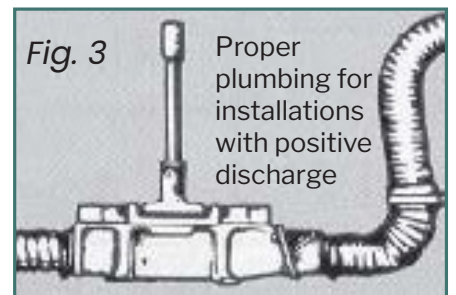
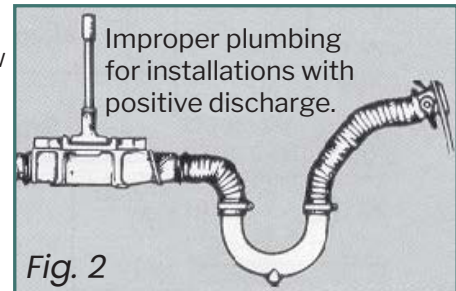
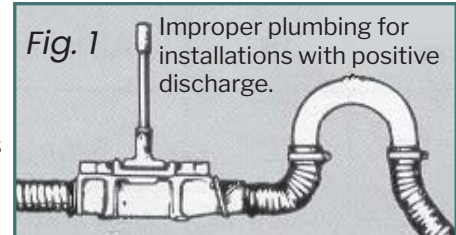

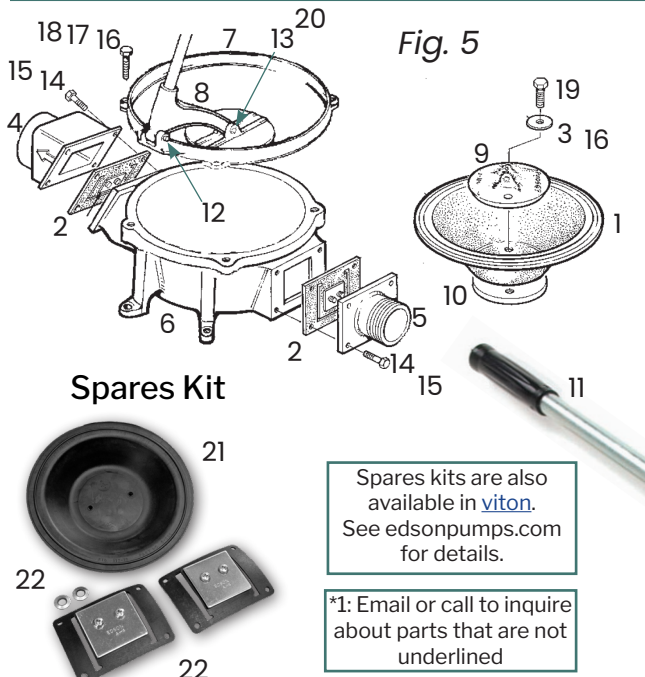

Key#	Part# ¹	Description	QTY
1	<u>113N-18</u>	Size 18 Diaphragm - Nitrile	1
2	<u>160-A-1207</u>	Valve Assembly - Nitrile	2
3	160-A-1253	1/4" Sealing Washer - Stainless	2
4	160-B-376A-150	1-1/2" Discharge Chamber - Alum.	1
5	160-B-375A	1-1/2" Suction Chamber - Alum.	1
6	160-B-378A	Side Inlet Pump Base - Alum.	1
7	160-B-374A	Headring Alum.	1
8	160-B-382A	Drive Arm - Alum.	1
9	160-A-1034A	Upper Standard - Alum.	1
10	160-A-1006	Lower Standard-SS	1
11	<u>160-A-1013AL</u>	18" Pump Handle with Grip	1
12	3/8-16x4"	Head Ring Pivot Bolt HHCS	1
13	960-A-1315E	Standard Pivot Pin	1
14	F1032-3/4-SC	10-32x3/4" Socket Cap Screw	8
15	F1032-FN	10-32 Nut Stainless	8
16	F1/4-LW	1/4" Lock Washer	6
17	F1/4-1.5-SC	1/4-20x1-1/2" Socket Cap Screw	4
18	F1/4-FN	1/4" Nuts Stainless	4
19	F1/4-1-SC	1/4-20x1" Socket Cap Screw	2
20	F1/8-3/4SS-CP	1/8"x3/4" Cotter Pin Stainless	2
Spares Kit - Nitrile (114N-18-220)			
21	<u>113N-18</u>	Size 18 Diaphragm-Nitrile	1
22	<u>160-A-1207</u>	Valve Assembly-Nitrile	2
23	160-A-1253	1/4" Sealing Washer-Stainless	2

Maintenance & Trouble Shooting

Pumps used for critical applications should be inspected and tested often.

For boat applications at least every six months, at annual commissioning and prior to off shore passage. Visually inspect pump inside and out for corrosion and wear. Lightly oil pivot pins. Pump some water. If the pump does not pump, check first for anything blocking the inlet line. If clear then see instructions below.

1. To check status of the pump and inlet plumbing all at once, seal the open end of the inlet plumbing. If you have a vacuum gauge, connect it to the open end of the inlet plumbing. If the plumbing is air tight, you should be able to build a vacuum of 9 to 10 inches of mercury. When you stop pumping the vacuum should very slowly bleed off. This procedure requires inlet plumbing of at least 4ft in length. If you can not establish or hold vacuum from the pump proceed to step 2.
2. Remove all plumbing from the pump.
3. To check the discharge valve assembly and diaphragm put your hand tightly over the pump inlet and pull back on the handle. You should feel a vacuum suction and if the discharge valve assembly and diaphragm are working properly, you should not be able to raise the diaphragm all the way. If you do not feel any suction, do the same thing again and listen for air being sucked in around the diaphragm. If you hear air movement, inspect for loose bolts or worn diaphragm. If you hear no air movement, remove the discharge chamber and inspect the valve assembly and valve seat. Clean or replace the valve and clean or resurface the valve seat as appropriate.
4. To check the inlet valve assembly raise the diaphragm; put your hand over the discharge and push forward on the handle. If the inlet valve is sealing properly, you should feel the pressure against your hand. If you don't, then remove the inlet chamber and inspect the valve assembly and valve seat. Clean or replace the valve and clean or resurface the valve seat as appropriate.
5. When you are sure the pump is working properly and the pump still will not pump liquid, check the inlet plumbing for leaks. Depending on the height above the liquid, even one unsealed fitting can prevent liquid from getting to the pump.

Performance & Specifications

Static Head: Suction-18ft/5.48m Discharge-18ft/5.48m
 Dry Suction Lift: 15ft/4.57m
 Volume: 18GPM/67.5 LPM at 5ft suction lift and 0ft discharge head at 48 Cycles per min. w/ 1-1/2" hose

Total volume depends on the pumping speed and the conditions when pumping. A cycle is one complete raising and lowering of the diaphragm. Static head is determined by the vertical height, length and size of the plumbing and the viscosity of the liquid. For most manual pump applications just measure the vertical distance between the liquid being pumped and the inlet of the pump. If it is within 15ft then you should be able to pump the liquid. See Installation guidelines for other considerations.

